

# TE Standard Series

## Extruded Channels for Tape Light

The Kichler TE Standard Series of Aluminum Extruded Tape Channels elevates your kitchen and shelving lighting projects. With simple mounting clips, varying depths for desired light diffusion, and snap-in lenses, these channels offer a polished look while simplifying the installation process. The TE Standard Series Channels are also available in kit form, for true ease of ordering.

### Surface Mount Kits



### Surface Mount Channels – A La Carte







### Recessed Mount Kits







### Recessed Mount Channels – A La Carte

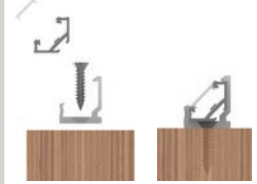
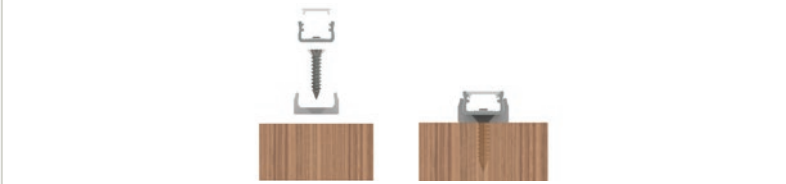
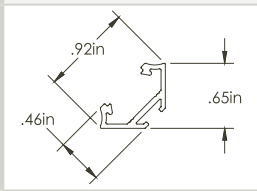
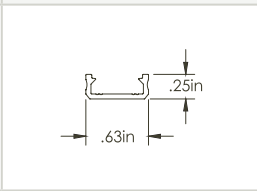
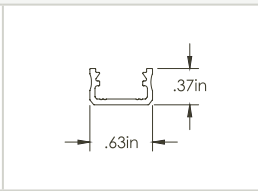
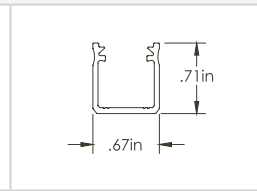
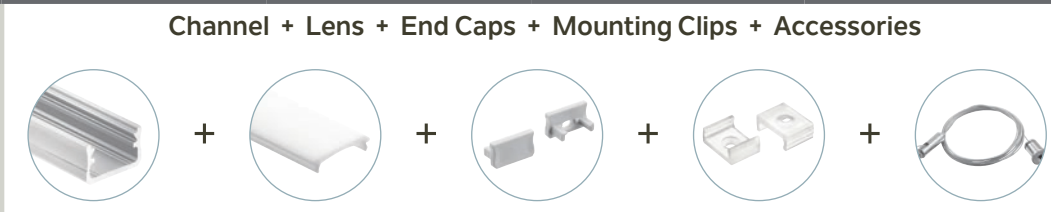

## TE Standard Series - Surface Mount

Kits	45-Degree	Shallow	Standard	Deep
<b>Full Kit</b>				
<b>Installation View</b>				
<b>Tape Capacity</b>	• Utilizes one strip of LED tape.			
<b>Description</b>	• Surface mount.			
	• 45° channel	• Sleek, cost effective, visible diodes	• Common depth offers gently diffused diodes	• Ideal depth for a spot-free lighting effect
<b>Dimensions</b>				
<b>Kit Models</b>	<p>Include: Channel, Lens (White Opaque), End Caps (2) and Mounting Clips (3, 5 or 9 for 2', 4' and 8' Kits respectively). Tape Light Sold Separately.</p> <p><b>45-Degree:</b>  <b>1TEK145SF2 SIL</b> – 2'  <b>1TEK145SF4 SIL</b> – 4'  <b>1TEK145SF8 SIL</b> – 8'</p>	<p><b>Shallow:</b>  <b>1TEK1SWSF2 SIL</b> – 2'  <b>1TEK1SWSF4 SIL</b> – 4'  <b>1TEK1SWSF8 SIL</b> – 8'</p>	<p><b>Standard:</b>  <b>1TEK1STSF2 SIL</b> – 2'  <b>1TEK1STSF4 SIL</b> – 4'  <b>1TEK1STSF8 SIL</b> – 8'</p>	<p><b>Deep:</b>  <b>1TEK1DWSF2 SIL</b> – 2'  <b>1TEK1DWSF4 SIL</b> – 4'  <b>1TEK1DWSF8 SIL</b> – 8'</p>
<b>A La Carte</b>	<b>Channel + Lens + End Caps + Mounting Clips + Accessories</b>			
<b>To Build A Channel</b>				
<b>Channels</b> 8ft	<b>1TEC145SF8 SIL</b>	<b>1TEC1SWSF8 SIL</b>	<b>1TEC1STSF8 SIL</b>	<b>1TEC1DWSF8 SIL</b>
<b>Lenses</b> 8ft	<b>1TEL0018 WHO</b> Flat White Opaque <b>1TEL0018 CLR</b> Flat Clear <b>1TEL1518 CLR</b> Narrow Beam Lens, Clear <b>1TEL3018 CLR</b> Medium Beam Lens, Clear			
	-	<b>1TE LH018 WHO</b> High Diffusion, White Opaque		-
<b>End Caps</b>	<b>1TEE145SFS SIL</b> <b>1TEE1SWSFS SIL</b> <b>1TEE1SWSFH SIL</b> Pairs with High Diffusion Lens			
<b>Mounting Clips</b> 10 total	<b>1TEE1STSF8 SIL</b> <b>1TEE1STSFH SIL</b> Pairs with High Diffusion Lens <b>1TEE1DWSFS SIL</b>			
<b>Accessories</b>	<b>1TEM145SFS CLR</b>			
	<b>1TEM1SWSFM CLR</b>			
<b>Accessories</b>	<b>1TEM1STSF8 CLR</b>			
<b>Accessories</b>	<b>1TEM1DWSFS CLR</b>			
<b>Accessories</b>	<b>1TEASPKSUS SIL</b> Pendant Cable			
<b>Accessories</b>	-	-	-	<b>1TEA1DWADJ8 SIL</b> Beam Spread Adjustment (see inside flap)

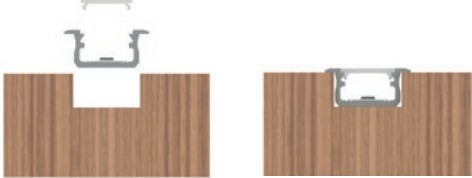
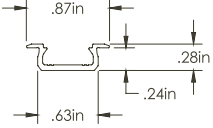
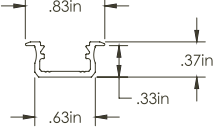
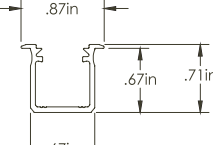
## TE Standard Series - Recessed Mount

Kits	Shallow	Standard	Deep
Full Kit			
Installation View			
Tape Capacity	• Utilizes one strip of LED Tape		
Description	<ul style="list-style-type: none"> <li>• Recessed installation (requires routing into wood or drywall)</li> </ul> Ideal for: <ul style="list-style-type: none"> <li>• Recessed under cabinets</li> <li>• Recessed into shelving or under a kitchen island</li> <li>• Wall or niche accent</li> </ul>		
Dimensions			
<b>Kit Models</b> Include: Channel, Lens (White Opaque), End Caps (2) and Mounting Clips (3, 5 or 9 for 2', 4' and 8' Kits respectively). Tape Light Sold Separately.	<b>Shallow:</b> 1TEK1SWRC2 SIL – 2' 1TEK1SWRC4 SIL – 4' 1TEK1SWRC8 SIL – 8'	<b>Standard:</b> 1TEK1STRC2 SIL – 2' 1TEK1STRC4 SIL – 4' 1TEK1STRC8 SIL – 8'	<b>Deep:</b> 1TEK1DWRC2 SIL – 2' 1TEK1DWRC4 SIL – 4' 1TEK1DWRC8 SIL – 8'
<b>A La Carte</b> <b>To Build A Channel</b> TE Standard Series Recessed channels also offer the option to build your own channel system. Tape Light Sold Separately	<b>Channel + Lens + End Caps</b> 		
Channels 8ft	1TEC1SWRC8 SIL	1TEC1STRC8 SIL	1TEC1DWRC8 SIL
Lenses 8ft	1TEL0018 WHO Flat White Opaque 1TEL0018 CLR Flat Clear 1TEL1518 CLR Narrow Beam Lens, Clear 1TEL3018 CLR Medium Beam Lens, Clear		
End Caps 10—all with hole for wire	1TEE1SWRCS SIL	1TEE1STRCS SIL	1TEE1DWRCS SIL

## Beam Spread Adjustment Accessory

Combine the Deep Well Surface Mount Channel (1TEC1DWSF8 SIL) with the Beam Spread Adjustment insert (1TEA1DWADJ8 SIL) and pair with either a flat, narrow and medium clear lens (1TEL-00/15/30-18CLR) to create one of nine custom beam spread options.

The Beam Spread Adjustment accessory (1TEA1DWADJ) can be inserted at the base of the channel, or inverted to elevate the LED placement to two different heights. The illustrations below depict the deep well channel without the adjustment accessory, as well as the effect achieved once inserted.

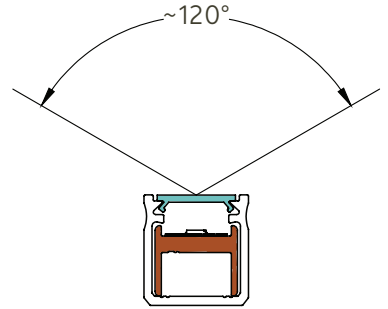
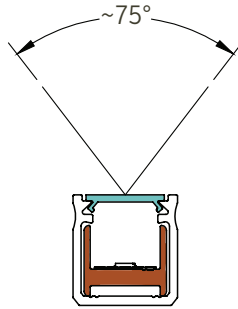
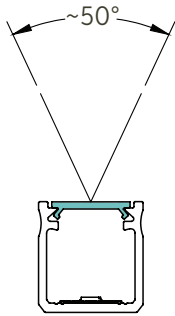

Shown with flat lens

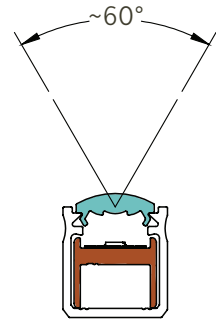
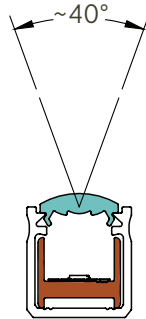
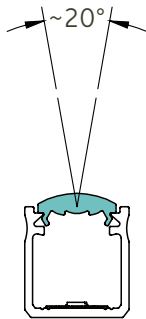

Shown with medium lens

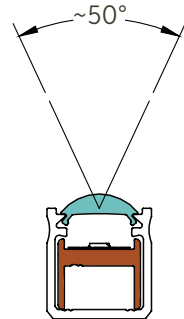
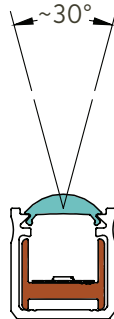
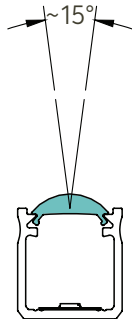

Shown with narrow lens

## Channel Depth

- **Shallow Channel** - sleek, cost effective, presents a light distribution that's true to its source
- **Standard Channel** - common depth offers a light distribution that is gently diffused
- **Deep Channel** - allows the light to blend within the channel, resulting in a greater diffused light

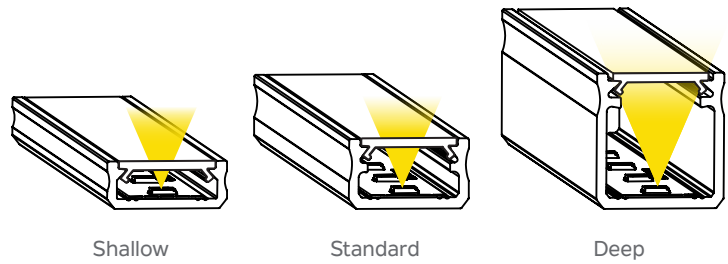

## Lens

- **Clear Lens** - allows the most light through, noting that diodes will be more visible
- **White Opaque Lens** - diffuses the diodes more, as well as disperses the light output
- **Narrow and Medium Lenses** - utilized to create a thinner, more direct beam for a desired end effect.
- **High Diffusion Lens** - sits up higher, creating more of a beam angle. The added height of the lens also works to disperse more light. This lens works with Shallow and Standard surface mount channels.



Clear



White Opaque



High Diffusion



Narrow



Medium

## Accessories

This pendant cable accessory broadens the application capabilities of the surface mount channels. Suspend a straight length of channel above an island or work station to create a custom, low-voltage pendant.



**1TEASPKSUS SIL**  
Pendant cable

To suspend channels  
as a fixture.



## TAPE SOLD SEPARATELY.

Kichler offers 6T Series 24V Tape as well as 4T Series 12V Tape.  
For a complete tape-to-channel compatibility matrix, refer to the  
TE Series Product Installation Guidelines on [Kichler.com](http://Kichler.com).

# Advanced Product Solutions (APS) & Layout

## Free layout and design services—and so much more.

From answering questions to creating detailed layouts to delivering a full bill of materials (BOM) – the Kichler APS & Layout team is your link to getting the job done. This free service takes the guesswork out of any lighting need you have: determining the scope of materials required, recommending dimmers and even creating a full wiring and product layout.

### Layout Design Services

Get to solutions faster and increase sales.

From choosing landscape lighting to maximizing a kitchen's functionality; from outfitting a restaurant with lighting to coordinating lighting throughout a home—these are just a few of the jobs our APS & Layout team can get done for you.

Contact us at [layouts@kichler.com](mailto:layouts@kichler.com) and we'll get you started:

- 1 Email us a completed Design Request Form (available at [Kichler.com/APS](http://Kichler.com/APS)) along with any drawings or pictures related to the job.
- 2 We'll create a BOM and email it back to you that same day (for all requests received by 3 pm EST).
- 3 Once you confirm the BOM and pricing, we'll return a completed layout design within 48 hours or less.

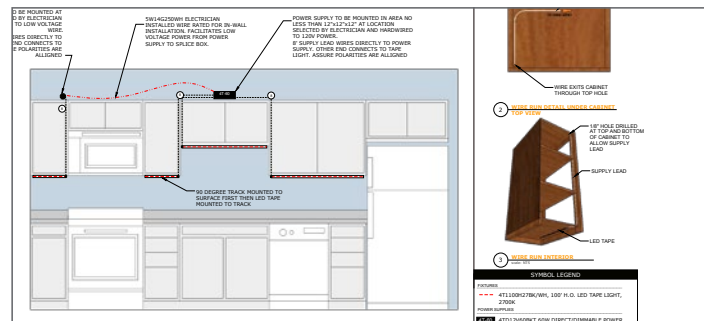

### Advanced Product Support

No question is too complex.

Installation issue? Building code question? Regulatory stumper? If you've got a challenging question—we've got you covered. Our Advanced Product Support team received additional classroom and in-field training on all Kichler products, so you can get your question answered quickly. To take advantage of this free service, call our dedicated Advanced Product Support line at **844-KICHLER (844-542-4537)** or email [techsupport@kichler.com](mailto:techsupport@kichler.com).

Indoor | Outdoor | Fans | Landscape | Lighting Systems

**KICHLER**